

同门电子科技

6000W台式机箱电源

PRODUCT CATALOG



COMPANY PROFILE

公司简介



企业使命

CORPORATE MISSION

做些感兴趣的事情

DO SOMETHING INTERESTING

企业愿景

CORPORATE VISION

成为电力电子行业最受欢迎的企业

TO BE THE MOST POPULAR ENTERPRISE IN THE POWER
ELECTRONICS INDUSTRY

企业核心价值观

CORPORATE CORE VALUES

创新 清洁 安全

INNOVATE / ENVIRONMENTAL / SAFE

东莞市同门电子科技有限公司座落在美丽的东莞松山湖高新科技园，公司实力雄厚，诚信经营，2017年被评为国家高新技术企业并获奖励。公司拥有自主知识产权，旗下拥有三大自主商标：eTOMMENS、同门、同门图形。目前公司已成功开发出三位、四位、五位、六位、开关、线性、小功率、大功率、单路、多路、台式、机柜式、普通、可编程等全系列电源，同门公司依托强大的开发创新能力，会持续推出多种高精度电源、变频电源、逆变器等，立志成为国内最专业的仪器仪表供应商。

东莞市同门电子科技有限公司全体同仁欢迎各位新老客户来电咨询、洽谈，共同发展，合作共赢。



生产能力

THROUGHPUT

拥有4层三仟多平米厂房，配有贴片机、波峰焊、较准设备等生产设备，月生产电源超1万台。

研发能力

R&D CAPABILITY

东莞市同门电子科技有限公司拥有强大的开发团队，与国内多家研发机构、高等院校合作，精通各种操作系统、硬件技术、编程技术、通信技术，已成功为国内多家公司合作开发生产出各种高档仪器仪表：精密直流电源、交流电源、超声波电源等。

公司目标

COMPANY OBJECTIVES

助力中国的产业升级、东莞机器人换人战略，为企业的“减员、增效、提质、保安全”作贡献。

支持服务

SUPPORT SERVICES

公司可为各企业提供技术支持、产品定制、上门维护，可联合研发、生产。

COMING SOON

>>>>>>



更多产品即将上市，敬请期待！

- 宽范围大功率电源？
- 并机技术？
- 嵌入式电源实时操作系统？
- 能源管理系统？
- 高压？大电流？恒功率？
- 交直流？
- 物联网技术？
- 超声波技术？

01

4旋钮电源 (电位器)

4位高精度台式开关电源系列



03

2旋钮电源 (编码器)

4位高精度台式开关电源系列

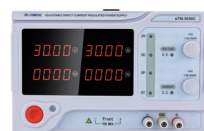

05

可编程电源

4位高精度台式开关电源系列



07

可编程黑金刚版电源

4位高精度台式开关电源系列



09

彩屏可编程电源

4位高精度台式开关电源系列



11

多路稳压稳流电源

台式多通道电源系列



13

三路可编程模块电源

4位高精度台式开关电源系列



6000W 高精度台式开关电源

4旋钮电源（电位器）常规系列

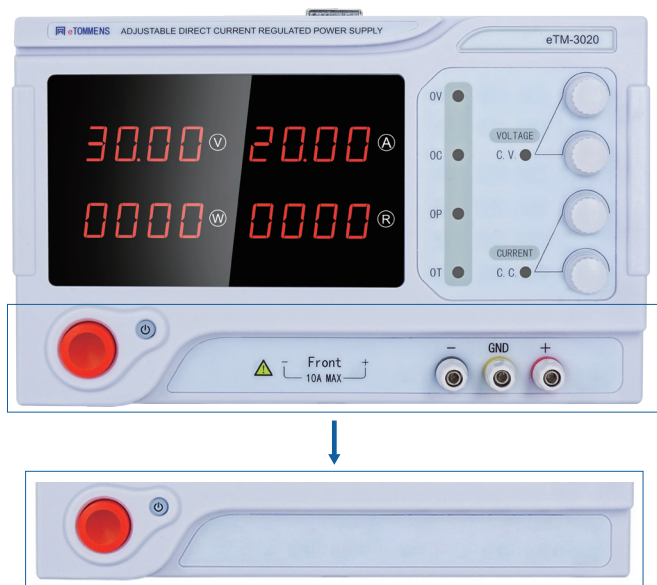

快速选型表

型号	电压	电流	功率
eTM-1560	15V	60A	900W
eTM-15100	15V	100A	1500W
eTM-2050	20V	50A	1000W
eTM-3020	30V	20A	600W
eTM-3030	30V	30A	900W
eTM-3050	30V	50A	1500W
eTM-3060	30V	60A	1800W
eTM-3080	30V	80A	2400W
eTM-30100	30V	100A	3000W
eTM-30150	30V	150A	4500W
eTM-30200	30V	200A	6000W
eTM-5020	50V	20A	1000W
eTM-5030	50V	30A	1500W
eTM-5050	50V	50A	2500W
eTM-5060	50V	60A	3000W
eTM-6010	60V	10A	600W
eTM-6015	60V	15A	900W
eTM-6020	60V	20A	1200W
eTM-6030	60V	30A	1800W
eTM-6050	60V	50A	3000W
eTM-6060	60V	60A	3600W
eTM-60100	60V	100A	6000W
eTM-8030	80V	30A	2400W
eTM-1005	100V	5A	500W
eTM-10010	100V	10A	1000W
eTM-10020	100V	20A	2000W
eTM-10030	100V	30A	3000W
eTM-10060	100V	60A	6000W
eTM-12010	120V	10A	1200W
eTM-12020	120V	20A	2400W
eTM-12030	120V	30A	3600W
eTM-1505	150V	5A	750W
eTM-15010	150V	10A	1500W
eTM-15030	150V	30A	4500W
eTM-2002	200V	2A	400W
eTM-2003	200V	3A	600W
eTM-2005	200V	5A	1000W
eTM-22010	220V	10A	2200W
eTM-22020	220V	20A	4400W
eTM-3002	300V	2A	600W
eTM-3003	300V	3A	900W
eTM-3005	300V	5A	1500W
eTM-30010	300V	10A	3000W
eTM-30020	300V	20A	6000W
eTM-4002	400V	2A	800W
eTM-4003	400V	3A	1200W
eTM-4005	400V	5A	2000W
eTM-40010	400V	10A	4000W
eTM-5002	500V	2A	1000W
eTM-5003	500V	3A	1500W
eTM-5005	500V	5A	2500W
eTM-5006	500V	6A	3000W
eTM-50010	500V	10A	5000W
eTM-6002	600V	2A	1200W
eTM-6003	600V	3A	1800W
eTM-6005	600V	5A	3000W
eTM-60010	600V	10A	6000W
eTM-8001	800V	1A	800W
eTM-8002	800V	2A	1600W
eTM-8003	800V	3A	2400W
eTM-8005	800V	5A	4000W
eTM-8006	800V	6A	4800W

注意：2400W以下型号有前面板输出端口
2400W以上型号及eTM-15100、eTM-10020没有前面板输出端口

应用场景



设备老化

灯具测试

产品特点

- 电压、电流可预置
- 过压、过流、过功率、过温、短路五重强大保护功能
- 后置SENSE补偿接口
- ON/OFF输出通断开关
- 电压电流细调
- 后置通讯接口（只能控制通断与读取，不能设置与编程）

面板说明 PANEL DESCRIPTION

前面板介绍



注意: 2400W以上型号没有前面板输出端口

后面板介绍



尺寸说明 DIMENSIONS DRAWING

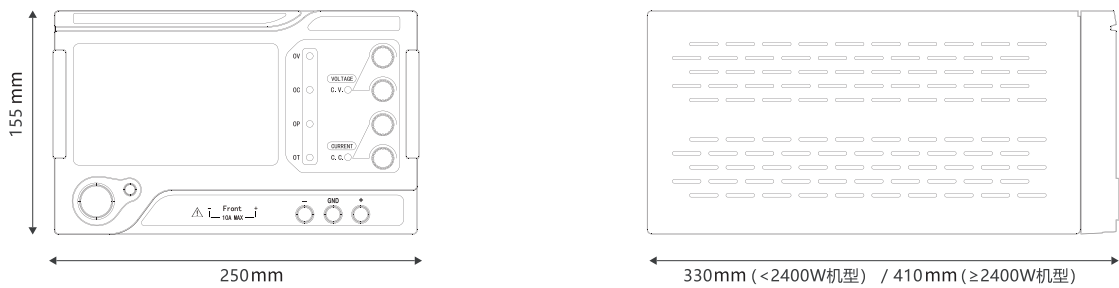

产品规格 SPECIFICATIONS

电源参数																
型号	eTM-1560	eTM-15100	eTM-2050	eTM-3020	eTM-3030	eTM-3050	eTM-3060	eTM-3080	eTM-30100	eTM-30150P	eTM-5020P	eTM-5030P	eTM-5050	eTM-5060	eTM-6010	eTM-6015
电压	0~15V	0~15V	0~20V	0~30V	0~30V	0~30V	0~30V	0~30V	0~30V	0~30V	0~50V	0~50V	0~50V	0~50V	0~60V	0~60V
电流	0~60A	0~100A	0~50A	0~20A	0~30A	0~50A	0~60A	0~80A	0~100A	0~150A	0~20A	0~30A	0~50A	0~60A	0~10A	0~15A
电源参数																
型号	eTM-6020	eTM-6030	eTM-6050	eTM-6060	eTM-60100	eTM-8030	eTM-1005	eTM-10010	eTM-10020	eTM-10030	eTM-10060	eTM-12010	eTM-12020	eTM-12030	eTM-1505	eTM-15010
电压	0~60V	0~60V	0~60V	0~60V	0~60V	0~80V	0~100V	0~100V	0~100V	0~100V	0~100V	0~120V	0~120V	0~120V	0~150V	0~150V
电流	0~20A	0~30A	0~50A	0~60A	0~100A	0~30A	0~5A	0~10A	0~20A	0~30A	0~60A	0~10A	0~20A	0~30A	0~5A	0~10A
电源参数																
型号	eTM-15030	eTM-2002	eTM-2003	eTM-2005	eTM-22010	eTM-22020	eTM-3002	eTM-3003	eTM-3005	eTM-30010	eTM-30020	eTM-4002	eTM-4003	eTM-4005	eTM-40010	eTM-5002
电压	0~15V	0~200V	0~200V	0~200V	0~220V	0~220V	0~300V	0~300V	0~300V	0~300V	0~300V	0~400V	0~400V	0~400V	0~400V	0~500V
电流	0~30A	0~2A	0~3A	0~5A	0~10A	0~20A	0~2A	0~3A	0~5A	0~10A	0~20A	0~2A	0~3A	0~5A	0~10A	0~2A
电源参数																
型号	eTM-5003	eTM-5005	eTM-5006	eTM-50010	eTM-6002	eTM-6003	eTM-6005	eTM-60010	eTM-8001	eTM-8002	eTM-8003	eTM-8005	eTM-8006			
电压	0~500V	0~500V	0~500V	0~500V	0~600V	0~600V	0~6005V	0~600V	0~800V	0~800V	0~800V	0~800V	0~800V			
电流	0~3A	0~5A	0~6A	0~10A	0~2A	0~3A	0~5A	0~10A	0~1A	0~2A	0~3A	0~5A	0~6A			
显示分辨率																
电压	<100V:10mV; ≥100V:100mV															
电流	<100A:10mA; ≥100A:100mA															
预设精度																
电压	0.1V															
电流	0.1A															
尺寸																
机身尺寸	<2400W机型: 330(D)×250(W)×155(H)mm / ≥2400W机型: 410(D)×250(W)×155(H)mm															
包装尺寸	<2400W机型: 420(D)×310(W)×220(H)mm / ≥2400W机型: 497(D)×310(W)×220(H)mm															
重量																
重量	净重: 5.5kg (<2400W型号)、8kg (≥2400W型号) / 毛重: 6.5kg (<2400W型号)、9.5kg (≥2400W型号)															
纹波及噪声																
纹波及噪声	≤1% (有效值)															
输出参数 (使用此规格时, 请确保开机15分钟以上)																

6000W 高精度台式开关电源

2旋钮电源（编码器）C系列

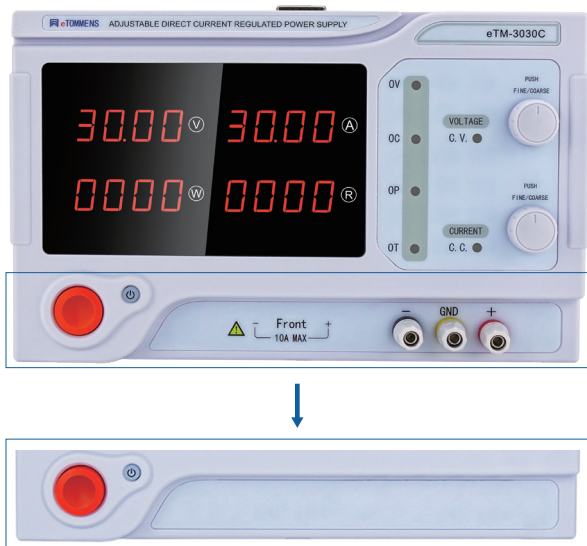

注意：2400W以下型号有前面板输出端口
2400W以上型号及eTM-15100C、eTM-10020C没有前面板输出端口

快速选型表

型号	电压	电流	功率
eTM-1560C	15V	60A	900W
eTM-15100C	15V	100A	1500W
eTM-2050C	20V	50A	1000W
eTM-3020C	30V	20A	600W
eTM-3030C	30V	30A	900W
eTM-3050C	30V	50A	1500W
eTM-3060C	30V	60A	1800W
eTM-3080C	30V	80A	2400W
eTM-30100C	30V	100A	3000W
eTM-30150C	30V	150A	4500W
eTM-30200C	30V	200A	6000W
eTM-5020C	50V	20A	1000W
eTM-5030C	50V	30A	1500W
eTM-5050C	50V	50A	2500W
eTM-5060C	50V	60A	3000W
eTM-6010C	60V	10A	600W
eTM-6015C	60V	15A	900W
eTM-6020C	60V	20A	1200W
eTM-6030C	60V	30A	1800W
eTM-6050C	60V	50A	3000W
eTM-6060C	60V	60A	3600W
eTM-60100C	60V	100A	6000W
eTM-8030C	80V	30A	2400W
eTM-1005C	100V	5A	500W
eTM-10010C	100V	10A	1000W
eTM-10020C	100V	20A	2000W
eTM-10030C	100V	30A	3000W
eTM-10060C	100V	60A	6000W
eTM-12010C	120V	10A	1200W
eTM-12020C	120V	20A	2400W
eTM-12030C	120V	30A	3600W
eTM-1505C	150V	5A	750W
eTM-15010C	150V	10A	1500W
eTM-15030C	150V	30A	4500W
eTM-2002C	200V	2A	400W
eTM-2003C	200V	3A	600W
eTM-2005C	200V	5A	1000W
eTM-22010C	220V	10A	2200W
eTM-22020C	220V	20A	4400W
eTM-3002C	300V	2A	600W
eTM-3003C	300V	3A	900W
eTM-3005C	300V	5A	1500W
eTM-30010C	300V	10A	3000W
eTM-30020C	300V	20A	6000W
eTM-4002C	400V	2A	800W
eTM-4003C	400V	3A	1200W
eTM-4005C	400V	5A	2000W
eTM-40010C	400V	10A	4000W
eTM-5002C	500V	2A	1000W
eTM-5003C	500V	3A	1500W
eTM-5005C	500V	5A	2500W
eTM-5006C	500V	6A	3000W
eTM-50010C	500V	10A	5000W
eTM-6002C	600V	2A	1200W
eTM-6003C	600V	3A	1800W
eTM-6005C	600V	5A	3000W
eTM-60010C	600V	10A	6000W
eTM-8001C	800V	1A	800W
eTM-8002C	800V	2A	1600W
eTM-8003C	800V	3A	2400W
eTM-8005C	800V	5A	4000W
eTM-8006C	800V	6A	4800W

应用场景



设备老化

灯具测试

产品特点

- 电压、电流可预置
- 电压电流编码开关控制
- 过压、过流、过功率、过温、短路五重强大保护功能
- ON/OFF输出通断开关
- 后置SENSE补偿接口
- 后置通讯接口（支持设置与编程）

面板说明 PANEL DESCRIPTION

前面板介绍



后面板介绍



注意: 2400W以上型号没有前面板输出端口

尺寸说明 DIMENSIONS DRAWING

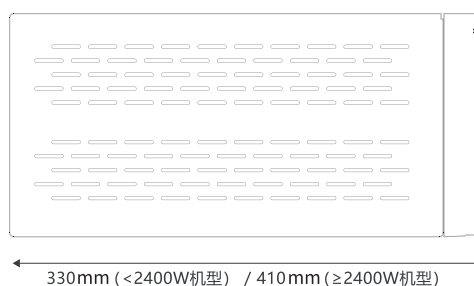
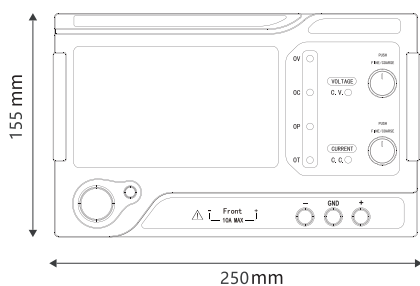

产品规格 SPECIFICATIONS

电源参数																
型号	eTM-1560C	eTM-15100C	eTM-2050C	eTM-3020C	eTM-3030C	eTM-3050C	eTM-3060C	eTM-3080C	eTM-30100C	eTM-30150C	eTM-5020C	eTM-5030C	eTM-5050C	eTM-5060C	eTM-6010C	eTM-6015C
电压	0~15V	0~15V	0~20V	0~30V	0~30V	0~30V	0~30V	0~30V	0~30V	0~30V	0~50V	0~50V	0~50V	0~50V	0~60V	0~60V
电流	0~60A	0~100A	0~50A	0~20A	0~30A	0~50A	0~60A	0~80A	0~100A	0~150A	0~20A	0~30A	0~50A	0~60A	0~10A	0~15A
电源参数																
型号	eTM-6020C	eTM-6030C	eTM-6050C	eTM-6060C	eTM-60100C	eTM-8030C	eTM-1005C	eTM-10010C	eTM-10020C	eTM-10030C	eTM-10060C	eTM-12010C	eTM-12020C	eTM-12030C	eTM-1505C	eTM-15010C
电压	0~60V	0~60V	0~60V	0~60V	0~60V	0~80V	0~100V	0~100V	0~100V	0~100V	0~100V	0~120V	0~120V	0~120V	0~150V	0~150V
电流	0~20A	0~30A	0~50A	0~60A	0~100A	0~30A	0~5A	0~10A	0~20A	0~30A	0~60A	0~10A	0~20A	0~30A	0~5A	0~10A
电源参数																
型号	eTM-15030C	eTM-2002C	eTM-2003C	eTM-2005C	eTM-22010C	eTM-22020C	eTM-3002C	eTM-3003C	eTM-3005C	eTM-30010C	eTM-30020C	eTM-4002C	eTM-4003C	eTM-4005C	eTM-40010C	eTM-5002C
电压	0~15V	0~200V	0~200V	0~200V	0~220V	0~220V	0~300V	0~300V	0~300V	0~300V	0~300V	0~400V	0~400V	0~400V	0~400V	0~500V
电流	0~30A	0~2A	0~3A	0~5A	0~10A	0~20A	0~2A	0~3A	0~5A	0~10A	0~20A	0~2A	0~3A	0~5A	0~10A	0~2A
电源参数																
型号	eTM-5003C	eTM-5005C	eTM-5006C	eTM-50010C	eTM-6002C	eTM-6003C	eTM-6005C	eTM-60010C	eTM-8001C	eTM-8002C	eTM-8003C	eTM-8005C	eTM-8006C			
电压	0~500V	0~500V	0~500V	0~500V	0~600V	0~600V	0~6005V	0~600V	0~800V	0~800V	0~800V	0~800V	0~800V			
电流	0~3A	0~5A	0~6A	0~10A	0~2A	0~3A	0~5A	0~10A	0~1A	0~2A	0~3A	0~5A	0~6A			
显示分辨率																
电压	<100V:10mV; ≥100V:100mV															
电流	<100A:10mA; ≥100A:100mA															
预设精度																
电压	0.1V															
电流	0.1A															
尺寸																
机身尺寸	<2400W机型: 330(D)×250(W)×155(H)mm / ≥2400W机型: 410(D)×250(W)×155(H)mm															
包装尺寸	<2400W机型: 420(D)×310(W)×220(H)mm / ≥2400W机型: 497(D)×310(W)×220(H)mm															
重量																
重量	净重: 5.5kg(<2400W型号)、8kg(≥2400W型号) / 毛重: 6.5kg(<2400W型号)、9.5kg(≥2400W型号)															
纹波及噪声																
输出参数(使用此规格时, 请确保开机15分钟以上)	≤1% (有效值)															

6000W 高精度台式开关电源

可编程电源P系列

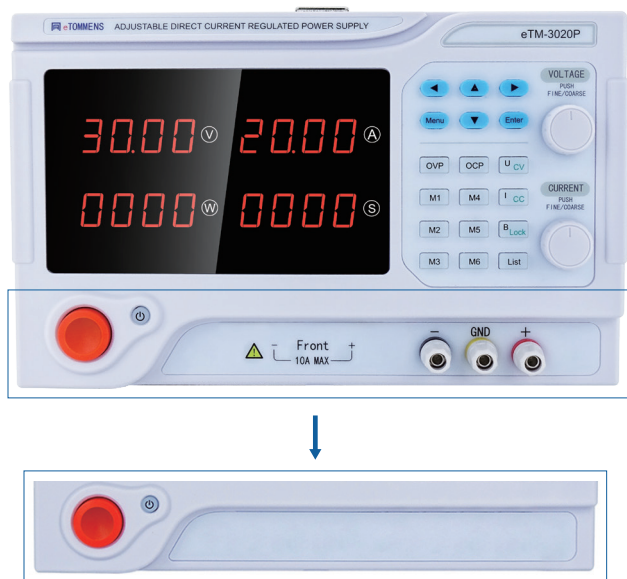

注意：2400W以下型号有前面板输出端口
2400W以上型号及eTM-15100P、eTM-10020P没有前面板输出端口

快速选型表

型号	电压	电流	功率
eTM-1560P	15V	60A	900W
eTM-15100P	15V	100A	1500W
eTM-2050P	20V	50A	1000W
eTM-3020P	30V	20A	600W
eTM-3030P	30V	30A	900W
eTM-3050P	30V	50A	1500W
eTM-3060P	30V	60A	1800W
eTM-3080P	30V	80A	2400W
eTM-30100P	30V	100A	3000W
eTM-30150P	30V	150A	4500W
eTM-30200P	30V	200A	6000W
eTM-5020P	50V	20A	1000W
eTM-5030P	50V	30A	1500W
eTM-5050P	50V	50A	2500W
eTM-5060P	50V	60A	3000W
eTM-6010P	60V	10A	600W
eTM-6015P	60V	15A	900W
eTM-6020P	60V	20A	1200W
eTM-6030P	60V	30A	1800W
eTM-6050P	60V	50A	3000W
eTM-6060P	60V	60A	3600W
eTM-60100P	60V	100A	6000W
eTM-8030P	80V	30A	2400W
eTM-1005P	100V	5A	500W
eTM-10010P	100V	10A	1000W
eTM-10020P	100V	20A	2000W
eTM-10030P	100V	30A	3000W
eTM-10060P	100V	60A	6000W
eTM-12010P	120V	10A	1200W
eTM-12020P	120V	20A	2400W
eTM-12030P	120V	30A	3600W
eTM-1505P	150V	5A	750W
eTM-15010P	150V	10A	1500W
eTM-15030P	150V	30A	4500W
eTM-2002P	200V	2A	400W
eTM-2003P	200V	3A	600W
eTM-2005P	200V	5A	1000W
eTM-22010P	220V	10A	2200W
eTM-22020P	220V	20A	4400W
eTM-3002P	300V	2A	600W
eTM-3003P	300V	3A	900W
eTM-3005P	300V	5A	1500W
eTM-30010P	300V	10A	3000W
eTM-30020P	300V	20A	6000W
eTM-4002P	400V	2A	800W
eTM-4003P	400V	3A	1200W
eTM-4005P	400V	5A	2000W
eTM-40010P	400V	10A	4000W
eTM-5002P	500V	2A	1000W
eTM-5003P	500V	3A	1500W
eTM-5005P	500V	5A	2500W
eTM-5006P	500V	6A	3000W
eTM-50010P	500V	10A	5000W
eTM-6002P	600V	2A	1200W
eTM-6003P	600V	3A	1800W
eTM-6005P	600V	5A	3000W
eTM-60010P	600V	10A	6000W
eTM-8001P	800V	1A	800W
eTM-8002P	800V	2A	1600W
eTM-8003P	800V	3A	2400W
eTM-8005P	800V	5A	4000W
eTM-8006P	800V	6A	4800W

应用场景



设备老化

灯具测试

产品特点

- 6组快捷参数回调及存储功能
- 带硬件List可编程序列输出
- 过压、过流、过功率、过温、短路五重强大保护功能
- 后置SENSE补偿接口
- ON/OFF输出通断开关
- 后置通讯接口（支持设置与编程）

面板说明 PANEL DESCRIPTION

前面板介绍

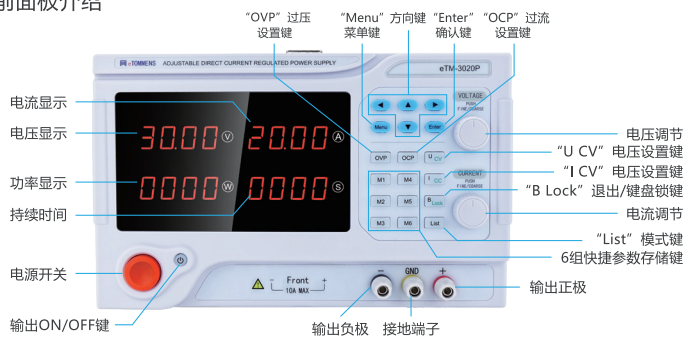

后面板介绍



注意: 2400W以上型号没有前面板输出端口

尺寸说明 DIMENSIONS DRAWING

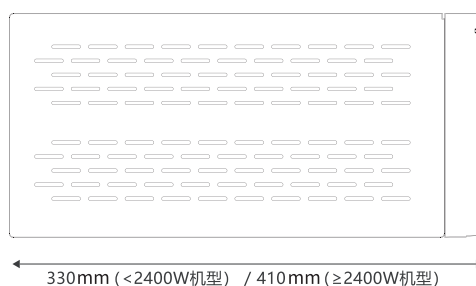
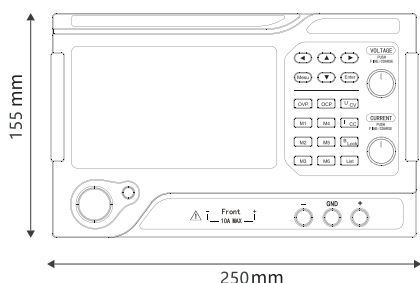

产品规格 SPECIFICATIONS

电源参数																
型号	eTM-1560P	eTM-15100P	eTM-2050P	eTM-3020P	eTM-3030P	eTM-3050P	eTM-3060P	eTM-3080P	eTM-30100P	eTM-30150P	eTM-5020P	eTM-5030P	eTM-5050P	eTM-5060P	eTM-6010P	eTM-6015P
电压	0~15V	0~15V	0~20V	0~30V	0~30V	0~30V	0~30V	0~30V	0~30V	0~30V	0~50V	0~50V	0~50V	0~50V	0~60V	0~60V
电流	0~60A	0~100A	0~50A	0~20A	0~30A	0~50A	0~60A	0~80A	0~100A	0~150A	0~20A	0~30A	0~50A	0~60A	0~10A	0~15A
电源参数																
型号	eTM-6020P	eTM-6030P	eTM-6050P	eTM-6060P	eTM-60100P	eTM-8030P	eTM-1005P	eTM-10010P	eTM-10020P	eTM-10030P	eTM-10060P	eTM-12010P	eTM-12020P	eTM-12030P	eTM-1505P	eTM-15010P
电压	0~60V	0~60V	0~60V	0~60V	0~60V	0~80V	0~100V	0~100V	0~100V	0~100V	0~100V	0~120V	0~120V	0~120V	0~150V	0~150V
电流	0~20A	0~30A	0~50A	0~60A	0~100A	0~30A	0~5A	0~10A	0~20A	0~30A	0~60A	0~10A	0~20A	0~30A	0~5A	0~10A
电源参数																
型号	eTM-15030P	eTM-2002P	eTM-2003P	eTM-2005P	eTM-22010P	eTM-22020P	eTM-3002P	eTM-3003P	eTM-3005P	eTM-30010P	eTM-30020P	eTM-4002P	eTM-4003P	eTM-4005P	eTM-40010P	eTM-5002P
电压	0~15V	0~200V	0~200V	0~200V	0~220V	0~220V	0~300V	0~300V	0~300V	0~300V	0~300V	0~400V	0~400V	0~400V	0~400V	0~500V
电流	0~30A	0~2A	0~3A	0~5A	0~10A	0~20A	0~2A	0~3A	0~5A	0~10A	0~20A	0~2A	0~3A	0~5A	0~10A	0~2A
电源参数																
型号	eTM-5003P	eTM-5005P	eTM-5006P	eTM-50010P	eTM-6002P	eTM-6003P	eTM-6005P	eTM-60010P	eTM-8001P	eTM-8002P	eTM-8003P	eTM-8005P	eTM-8006P			
电压	0~500V	0~500V	0~500V	0~500V	0~600V	0~600V	0~600V	0~600V	0~800V	0~800V	0~800V	0~800V	0~800V			
电流	0~3A	0~5A	0~6A	0~10A	0~2A	0~3A	0~5A	0~10A	0~1A	0~2A	0~3A	0~5A	0~6A			
显示分辨率																
电压	<100V:10mV; ≥100V:100mV															
电流	<100A:10mA; ≥100A:100mA															
预设精度																
电压	0.1V															
电流	0.1A															
尺寸																
机身尺寸	<2400W机型: 330(D)×250(W)×155(H)mm / ≥2400W机型: 410(D)×250(W)×155(H)mm															
包装尺寸	<2400W机型: 420(D)×310(W)×220(H)mm / ≥2400W机型: 497(D)×310(W)×220(H)mm															
重量																
重量	净重: 5.5kg (<2400W型号)、8kg (≥2400W型号) / 毛重: 6.5kg (<2400W型号)、9.5kg (≥2400W型号)															
纹波及噪声																
输出参数 (使用此规格时, 请确保开机15分钟以上)	≤1% (有效值)															

6000W 高精度台式开关电源

可编程电源黑金刚PC系列



注意：2400W以下型号有前面板输出端口
2400W以上型号及eTM-15100PC、eTM-10020PC没有前面板输出端口

应用场景



设备老化



灯具测试

产品特点

- 6组快捷参数回调及存储功能
- 带硬件List可编程序列输出
- 过压、过流、过功率、过温、短路五重强大保护功能
- 后置SENSE补偿接口
- ON/OFF输出通断开关
- 后置通讯接口（支持设置与编程）

快速选型表

型号	电压	电流	功率
eTM-1560PC	15V	60A	900W
eTM-15100PC	15V	100A	1500W
eTM-2050PC	20V	50A	1000W
eTM-3020PC	30V	20A	600W
eTM-3030PC	30V	30A	900W
eTM-3050PC	30V	50A	1500W
eTM-3060PC	30V	60A	1800W
eTM-3080PC	30V	80A	2400W
eTM-30100PC	30V	100A	3000W
eTM-30150PC	30V	150A	4500W
eTM-30200PC	30V	200A	6000W
eTM-5020PC	50V	20A	1000W
eTM-5030PC	50V	30A	1500W
eTM-5050PC	50V	50A	2500W
eTM-5060PC	50V	60A	3000W
eTM-6010PC	60V	10A	600W
eTM-6015PC	60V	15A	900W
eTM-6020PC	60V	20A	1200W
eTM-6030PC	60V	30A	1800W
eTM-6050PC	60V	50A	3000W
eTM-6060PC	60V	60A	3600W
eTM-60100PC	60V	100A	6000W
eTM-8030PC	80V	30A	2400W
eTM-1005PC	100V	5A	500W
eTM-10010PC	100V	10A	1000W
eTM-10020PC	100V	20A	2000W
eTM-10030PC	100V	30A	3000W
eTM-10060PC	100V	60A	6000W
eTM-12010PC	120V	10A	1200W
eTM-12020PC	120V	20A	2400W
eTM-12030PC	120V	30A	3600W
eTM-1505PC	150V	5A	750W
eTM-15010PC	150V	10A	1500W
eTM-15030PC	150V	30A	4500W
eTM-2002PC	200V	2A	400W
eTM-2003PC	200V	3A	600W
eTM-2005PC	200V	5A	1000W
eTM-22010PC	220V	10A	2200W
eTM-22020PC	220V	20A	4400W
eTM-3002PC	300V	2A	600W
eTM-3003PC	300V	3A	900W
eTM-3005PC	300V	5A	1500W
eTM-30010PC	300V	10A	3000W
eTM-30020PC	300V	20A	6000W
eTM-4002PC	400V	2A	800W
eTM-4003PC	400V	3A	1200W
eTM-4005PC	400V	5A	2000W
eTM-40010PC	400V	10A	4000W
eTM-5002PC	500V	2A	1000W
eTM-5003PC	500V	3A	1500W
eTM-5005PC	500V	5A	2500W
eTM-5006PC	500V	6A	3000W
eTM-50010PC	500V	10A	5000W
eTM-6002PC	600V	2A	1200W
eTM-6003PC	600V	3A	1800W
eTM-6005PC	600V	5A	3000W
eTM-60010PC	600V	10A	6000W
eTM-8001PC	800V	1A	800W
eTM-8002PC	800V	2A	1600W
eTM-8003PC	800V	3A	2400W
eTM-8005PC	800V	5A	4000W
eTM-8006PC	800V	6A	4800W

面板说明 PANEL DESCRIPTION

前面板介绍



后面板介绍



注意：2400W以上型号没有前面板输出端口

尺寸说明 DIMENSIONS DRAWING

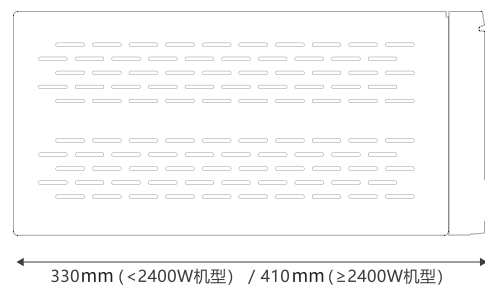
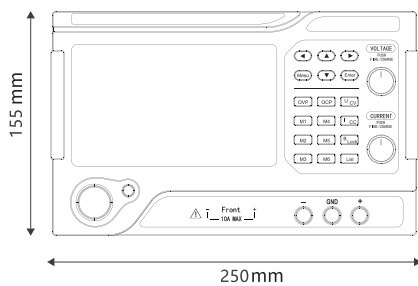

产品规格 SPECIFICATIONS

电源参数																
型号	eTM-1560PC	eTM-15100PC	eTM-2050PC	eTM-3020PC	eTM-3030PC	eTM-3050PC	eTM-3060PC	eTM-3080PC	eTM-30100PC	eTM-30150PC	eTM-5020PC	eTM-5030PC	eTM-5050PC	eTM-5060PC	eTM-6010PC	eTM-6015PC
电压	0~15V	0~15V	0~20V	0~30V	0~30V	0~30V	0~30V	0~30V	0~30V	0~30V	0~50V	0~50V	0~50V	0~50V	0~60V	0~60V
电流	0~60A	0~100A	0~50A	0~20A	0~30A	0~50A	0~60A	0~80A	0~100A	0~150A	0~20A	0~30A	0~50A	0~60A	0~10A	0~15A
电源参数																
型号	eTM-6020PC	eTM-6030PC	eTM-6050PC	eTM-6060PC	eTM-60100PC	eTM-8030PC	eTM-1005PC	eTM-10010PC	eTM-10020PC	eTM-10030PC	eTM-10060PC	eTM-12010PC	eTM-12020PC	eTM-12030PC	eTM-1505PC	eTM-15010PC
电压	0~60V	0~60V	0~60V	0~60V	0~60V	0~80V	0~100V	0~100V	0~100V	0~100V	0~100V	0~120V	0~120V	0~120V	0~150V	0~150V
电流	0~20A	0~30A	0~50A	0~60A	0~100A	0~30A	0~5A	0~10A	0~20A	0~30A	0~60A	0~10A	0~20A	0~30A	0~5A	0~10A
电源参数																
型号	eTM-15030PC	eTM-2002PC	eTM-2003PC	eTM-2005PC	eTM-22010PC	eTM-22020PC	eTM-3002PC	eTM-3003PC	eTM-3005PC	eTM-30010PC	eTM-30020PC	eTM-4002PC	eTM-4003PC	eTM-4005PC	eTM-40010PC	eTM-5002PC
电压	0~15V	0~200V	0~200V	0~200V	0~220V	0~220V	0~300V	0~300V	0~300V	0~300V	0~300V	0~400V	0~400V	0~400V	0~400V	0~500V
电流	0~30A	0~2A	0~3A	0~5A	0~10A	0~20A	0~2A	0~3A	0~5A	0~10A	0~20A	0~2A	0~3A	0~5A	0~10A	0~2A
电源参数																
型号	eTM-5003PC	eTM-5005PC	eTM-5006PC	eTM-50010PC	eTM-6002PC	eTM-6003PC	eTM-6005PC	eTM-60010PC	eTM-8001PC	eTM-8002PC	eTM-8003PC	eTM-8005PC	eTM-8006PC			
电压	0~500V	0~500V	0~500V	0~500V	0~600V	0~600V	0~600V	0~600V	0~800V	0~800V	0~800V	0~800V	0~800V			
电流	0~3A	0~5A	0~6A	0~10A	0~2A	0~3A	0~5A	0~10A	0~1A	0~2A	0~3A	0~5A	0~6A			
显示分辨率																
电压	<100V:10mV; ≥100V:100mV															
电流	<100A:10mA; ≥100A:100mA															
预设精度																
电压	0.1V															
电流	0.1A															
尺寸																
机身尺寸	<2400W机型: 330(D)×250(W)×155(H)mm / ≥2400W机型: 410(D)×250(W)×155(H)mm															
包装尺寸	<2400W机型: 420(D)×310(W)×220(H)mm / ≥2400W机型: 497(D)×310(W)×220(H)mm															
重量																
重量	净重: 5.5kg (<2400W型号)、8kg (≥2400W型号) / 毛重: 6.5kg (<2400W型号)、9.5kg (≥2400W型号)															
纹波及噪声																
输出参数 (使用此规格时, 请确保开机15分钟以上)	≤1% (有效值)															

6000W 高精度台式开关电源

彩屏可编程电源PL系列



注意：2400W以下型号有前面板输出端口
2400W以上型号及eTM-15100PL、eTM-10020PL没有前面板输出端口

应用场景



熔断测试



电池充电

产品特点

- 保险丝熔断测试模式
- 电池曲线充电模式
- 多种计时模式，多种场景适用
- 先进的嵌入式系统
- 彩屏显示，现代简洁的界面设计
- 多重保护模式，提供全方位保护
- 后背板标配串口

快速选型表

型号	电压	电流	功率
eTM-1560PL	15V	60A	900W
eTM-15100PL	15V	100A	1500W
eTM-2050PL	20V	50A	1000W
eTM-3020PL	30V	20A	600W
eTM-3030PL	30V	30A	900W
eTM-3050PL	30V	50A	1500W
eTM-3060PL	30V	60A	1800W
eTM-3080PL	30V	80A	2400W
eTM-30100PL	30V	100A	3000W
eTM-30150PL	30V	150A	4500W
eTM-30200PL	30V	200A	6000W
eTM-5020PL	50V	20A	1000W
eTM-5030PL	50V	30A	1500W
eTM-5050PL	50V	50A	2500W
eTM-5060PL	50V	60A	3000W
eTM-6010PL	60V	10A	600W
eTM-6015PL	60V	15A	900W
eTM-6020PL	60V	20A	1200W
eTM-6030PL	60V	30A	1800W
eTM-6050PL	60V	50A	3000W
eTM-6060PL	60V	60A	3600W
eTM-60100PL	60V	100A	6000W
eTM-8030PL	80V	30A	2400W
eTM-1005PL	100V	5A	500W
eTM-10010PL	100V	10A	1000W
eTM-10020PL	100V	20A	2000W
eTM-10030PL	100V	30A	3000W
eTM-10060PL	100V	60A	6000W
eTM-12010PL	120V	10A	1200W
eTM-12020PL	120V	20A	2400W
eTM-12030PL	120V	30A	3600W
eTM-1505PL	150V	5A	750W
eTM-15010PL	150V	10A	1500W
eTM-15030PL	150V	30A	4500W
eTM-2002PL	200V	2A	400W
eTM-2003PL	200V	3A	600W
eTM-2005PL	200V	5A	1000W
eTM-22010PL	220V	10A	2200W
eTM-22020PL	220V	20A	4400W
eTM-3002PL	300V	2A	600W
eTM-3003PL	300V	3A	900W
eTM-3005PL	300V	5A	1500W
eTM-30010PL	300V	10A	3000W
eTM-30020PL	300V	20A	6000W
eTM-4002PL	400V	2A	800W
eTM-4003PL	400V	3A	1200W
eTM-4005PL	400V	5A	2000W
eTM-40010PL	400V	10A	4000W
eTM-5002PL	500V	2A	1000W
eTM-5003PL	500V	3A	1500W
eTM-5005PL	500V	5A	2500W
eTM-5006PL	500V	6A	3000W
eTM-50010PL	500V	10A	5000W
eTM-6002PL	600V	2A	1200W
eTM-6003PL	600V	3A	1800W
eTM-6005PL	600V	5A	3000W
eTM-60010PL	600V	10A	6000W
eTM-8001PL	800V	1A	800W
eTM-8002PL	800V	2A	1600W
eTM-8003PL	800V	3A	2400W
eTM-8005PL	800V	5A	4000W
eTM-8006PL	800V	6A	4800W

面板说明 PANEL DESCRIPTION

前面板介绍



后面板介绍



尺寸说明 DIMENSIONS DRAWING

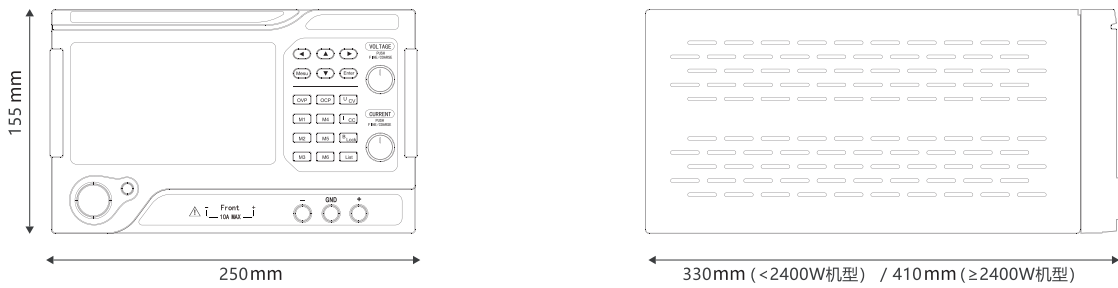

产品规格 SPECIFICATIONS

电源参数																
型号	eTM-1560PL	eTM-15100PL	eTM-2050PL	eTM-3020PL	eTM-3030PL	eTM-3050PL	eTM-3060PL	eTM-3080PL	eTM-30100PL	eTM-30150PL	eTM-5020PL	eTM-5030PL	eTM-5050PL	eTM-5060PL	eTM-6010PL	eTM-6015PL
电压	0~15V	0~15V	0~20V	0~30V	0~30V	0~30V	0~30V	0~30V	0~30V	0~30V	0~50V	0~50V	0~50V	0~50V	0~60V	0~60V
电流	0~60A	0~100A	0~50A	0~20A	0~30A	0~50A	0~60A	0~80A	0~100A	0~150A	0~20A	0~30A	0~50A	0~60A	0~10A	0~15A
电源参数																
型号	eTM-6020PL	eTM-6030PL	eTM-6050PL	eTM-6060PL	eTM-60100PL	eTM-8030PL	eTM-1005PL	eTM-10010PL	eTM-10020PL	eTM-10030PL	eTM-10060PL	eTM-12010PL	eTM-12020PL	eTM-12030PL	eTM-1505PL	eTM-15010PL
电压	0~60V	0~60V	0~60V	0~60V	0~60V	0~80V	0~100V	0~100V	0~100V	0~100V	0~100V	0~120V	0~120V	0~120V	0~150V	0~150V
电流	0~20A	0~30A	0~50A	0~60A	0~100A	0~30A	0~5A	0~10A	0~20A	0~30A	0~60A	0~10A	0~20A	0~30A	0~5A	0~10A
电源参数																
型号	eTM-15030PL	eTM-2002PL	eTM-2003PL	eTM-2005PL	eTM-22010PL	eTM-22020PL	eTM-3002PL	eTM-3003PL	eTM-3005PL	eTM-30010PL	eTM-30020PL	eTM-4002PL	eTM-4003PL	eTM-4005PL	eTM-40010PL	eTM-5002PL
电压	0~15V	0~200V	0~200V	0~200V	0~220V	0~220V	0~300V	0~300V	0~300V	0~300V	0~300V	0~400V	0~400V	0~400V	0~400V	0~500V
电流	0~30A	0~2A	0~3A	0~5A	0~10A	0~20A	0~2A	0~3A	0~5A	0~10A	0~20A	0~2A	0~3A	0~5A	0~10A	0~2A
电源参数																
型号	eTM-5003PL	eTM-5005PL	eTM-5006PL	eTM-50010PL	eTM-6002PL	eTM-6003PL	eTM-6005PL	eTM-60010PL	eTM-8001PL	eTM-8002PL	eTM-8003PL	eTM-8005PL	eTM-8006PL			
电压	0~500V	0~500V	0~500V	0~500V	0~600V	0~600V	0~600V	0~600V	0~800V	0~800V	0~800V	0~800V	0~800V			
电流	0~3A	0~5A	0~6A	0~10A	0~2A	0~3A	0~5A	0~10A	0~1A	0~2A	0~3A	0~5A	0~6A			
显示分辨率																
电压	<100V:10mV; ≥100V:100mV															
电流	<100A:10mA; ≥100A:100mA															
预设精度																
电压	0.1V															
电流	0.1A															
尺寸																
机身尺寸	<2400W机型: 330(D)×250(W)×155(H)mm / ≥2400W机型: 410(D)×250(W)×155(H)mm															
包装尺寸	<2400W机型: 420(D)×310(W)×220(H)mm / ≥2400W机型: 497(D)×310(W)×220(H)mm															
重量																
重量	净重: 5.5kg (<2400W型号)、8kg (≥2400W型号) / 毛重: 6.5kg (<2400W型号)、9.5kg (≥2400W型号)															
纹波及噪声																
	≤1% (有效值)															
熔断测量时间精度																
	50ms															
输出参数 (使用此规格时, 请确保持开机15分钟以上)																

高精度台式多路电源

直流稳压多路线性电源

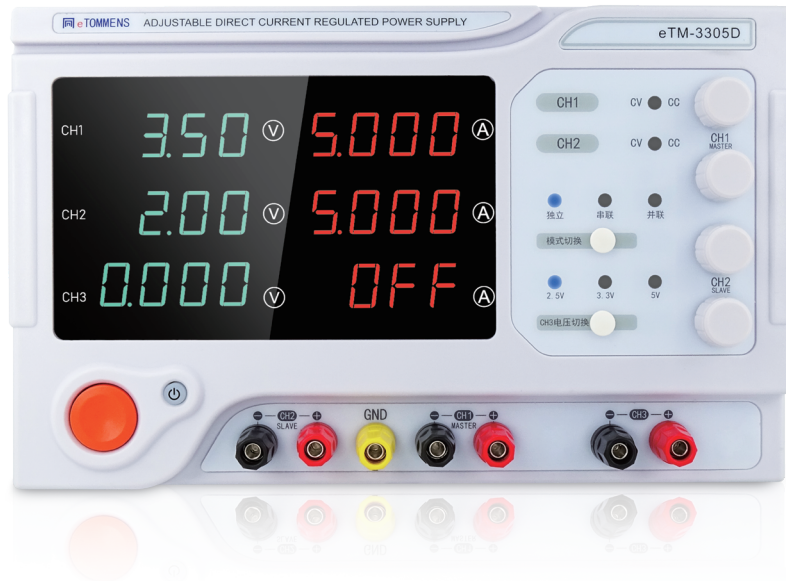

应用场景



电子实验室



大专院校

产品特点

- 主路CH1、CH2具有主从跟踪、并联、串联功能
- 从路CH3快捷输出功能，可快捷方便切换固定电压为2.5V/3.3V/5V
- 主路CH1、CH2分辨率：10mv、1mA
- 从路CH3分辨率：1mA、1mA
- 过压、过流、过功率、过温、短路五重强大保护功能

面板说明 PANEL DESCRIPTION

前面板介绍

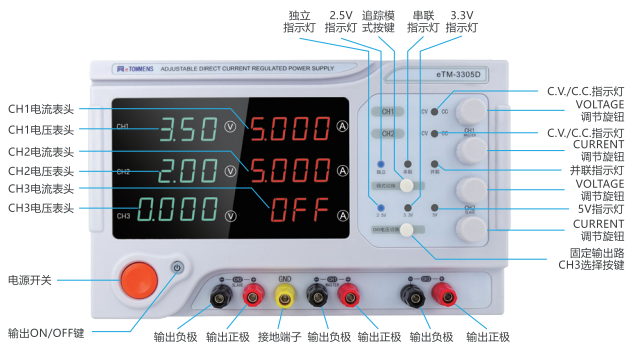

后面板介绍



尺寸说明 DIMENSIONS DRAWING

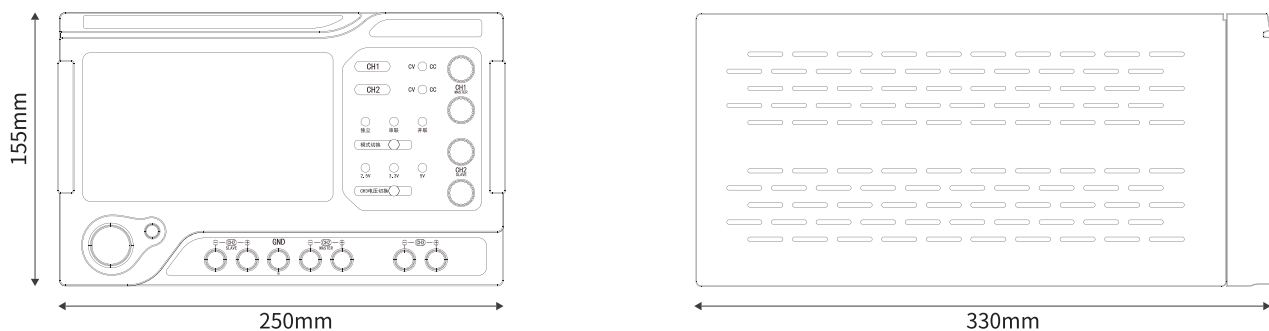

产品规格 SPECIFICATIONS

电源参数

型号	eTM-3303D			eTM-3305D		
通道	CH1	CH2	CH3	CH1	CH2	CH3
电压	0 ~ 30V	0 ~ 30V	2.5V/3.3V/5V Fixed	0 ~ 30V	0 ~ 30V	2.5V/3.3V/5V Fixed
电流	0 ~ 3A	0 ~ 3A	3A Max	0 ~ 5A	0 ~ 5A	3A Max

纹波

电压	$\leq 1\text{mVrms}$	$\leq 1\text{mVrms}$	$\leq 2\text{mVrms}(5\text{Hz}\sim 1\text{MHz})$	$\leq 0.01\% + 3\text{mV}(I \leq 3\text{A})$ $\leq 0.02\% + 5\text{mV}(I > 3\text{A})$	$\leq 0.01\% + 3\text{mV}(I \leq 3\text{A})$ $\leq 0.02\% + 5\text{mV}(I > 3\text{A})$	$\leq 2\text{mVrms}(5\text{Hz}\sim 1\text{MHz})$
电流	$\leq 3\text{mArms}$	$\leq 3\text{mArms}$	/	$\leq 3\text{mArms}(I \leq 3\text{A})$ $\leq 10\text{mArms}(I > 3\text{A})$	$\leq 3\text{mArms}(I \leq 3\text{A})$ $\leq 10\text{mArms}(I > 3\text{A})$	/

跟踪操作

跟踪误差	0.5%+10mV (CH1)			0.5%+10mV (CH1)		
电源调整率	$\leq 0.01\% + 3\text{mV}$			$\leq 0.01\% + 3\text{mV}$		
负载调整率	$\leq 300\text{mV}$			$\leq 300\text{mV}$		
纹波噪声	$\leq 2\text{mVrms}(5\text{Hz}\sim 1\text{MHz})$			$\leq 2\text{mVrms}(5\text{Hz}\sim 1\text{MHz})$		

尺寸

机身尺寸	330(D)×250(W)×155(H)mm
包装尺寸	420(D)×310(W)×220(H)mm

重量

重量	净重: 7.5kg/毛重: 11.5kg
----	----------------------

高精度台式多路电源

三路可编程模块电源DM系列

应用领域



电子实验室



大专院校



产品特点

- 各输出通道都有11种模块选择
- 各输出通道可独立控制通端
- 可编程设置，支持MODBUS通信协议
- 后背板标配RS232/RS485/USB串口
- 编码开关数字控制便捷、稳定耐用
- 各通道三组预置参数存储功能
- OVP、OCP阈值可直接设定

快速选型表

型号	功率	电压	电流	功率
A	满功率输出	15V	2A	30W
B	满功率输出	15V	5A	75W
C	满功率输出	30V	5A	150W
D	满功率输出	30V	10A	300W
E	满功率输出	60V	5A	300W
F	满功率输出	100V	3A	300W
G	满功率输出	15V	20A	300W
H	满功率输出	150V	2A	300W
I	宽范围输出	40V	20A	300W
J	宽范围输出	80V	10A	300W
K	宽范围输出	160V	5A	300W

面板说明 PANEL DESCRIPTION

前面板介绍



后面板介绍



注意：2400W以上型号没有前面板输出端口

尺寸说明 DIMENSIONS DRAWING

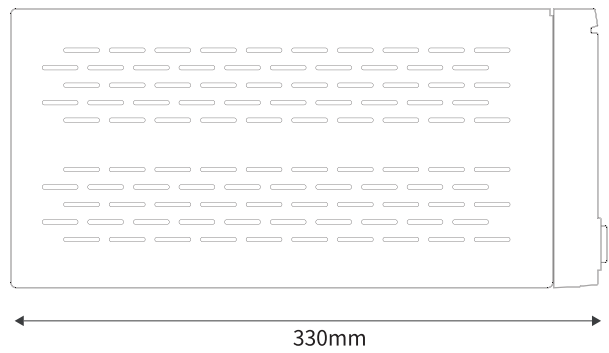
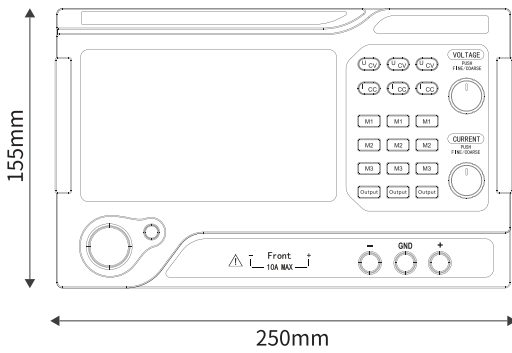

产品规格 SPECIFICATIONS

电源参数

型号	A	B	C	D	E	F	G	H	I	J	K
电压	0~15V	0~15V	0~30V	0~30V	0~60V	0~100V	0~15V	0~150V	0~40V	0~80V	0~160V
电流	0~2A	0~5A	0~5A	0~10A	0~5A	0~3A	0~20A	0~2A	0~20A	0~10A	0~5A

设定分辨率

电压	< 100V: 10mV ; ≥ 100V: 0.1V	< 100V: 10mV ; ≥ 100V: 0.1V
电流	< 10A: 1mA ; ≥ 10A: 10mA	< 10A: 1mA ; ≥ 10A: 10mA

设定精度

电压	≤ 0.1% + 5digits	≤ 0.1% + 2digits
电流	≤ 0.2% + 10digits	≤ 0.2% + 3digits

纹波

电压	≤ 10mVrms	≤ 10mVrms	≤ 10mVrms	≤ 10mVrms	≤ 15mVrms	≤ 18mVrms	≤ 10mVrms	≤ 20mVrms	≤ 12mVrms	≤ 12mVrms	≤ 12mVrms
电流	≤ 10mArms	≤ 10mArms	≤ 10mArms	≤ 10mArms	≤ 15mArms	≤ 18mArms	≤ 10mArms	≤ 20mArms	≤ 18mArms	≤ 18mArms	≤ 26mArms

重量

重量 净重: 5.5kg/毛重: 6.5kg

东莞市同门电子科技有限公司

Dongguan eTOMMENS electronic technology Co., Ltd

电 话:0769-23073220

传 真:0769-23073220

官方网址:www.etommens.com

地 址:东莞市松山湖园区学府路1号12栋1605室

